

BL-451 STONE ANCHOR

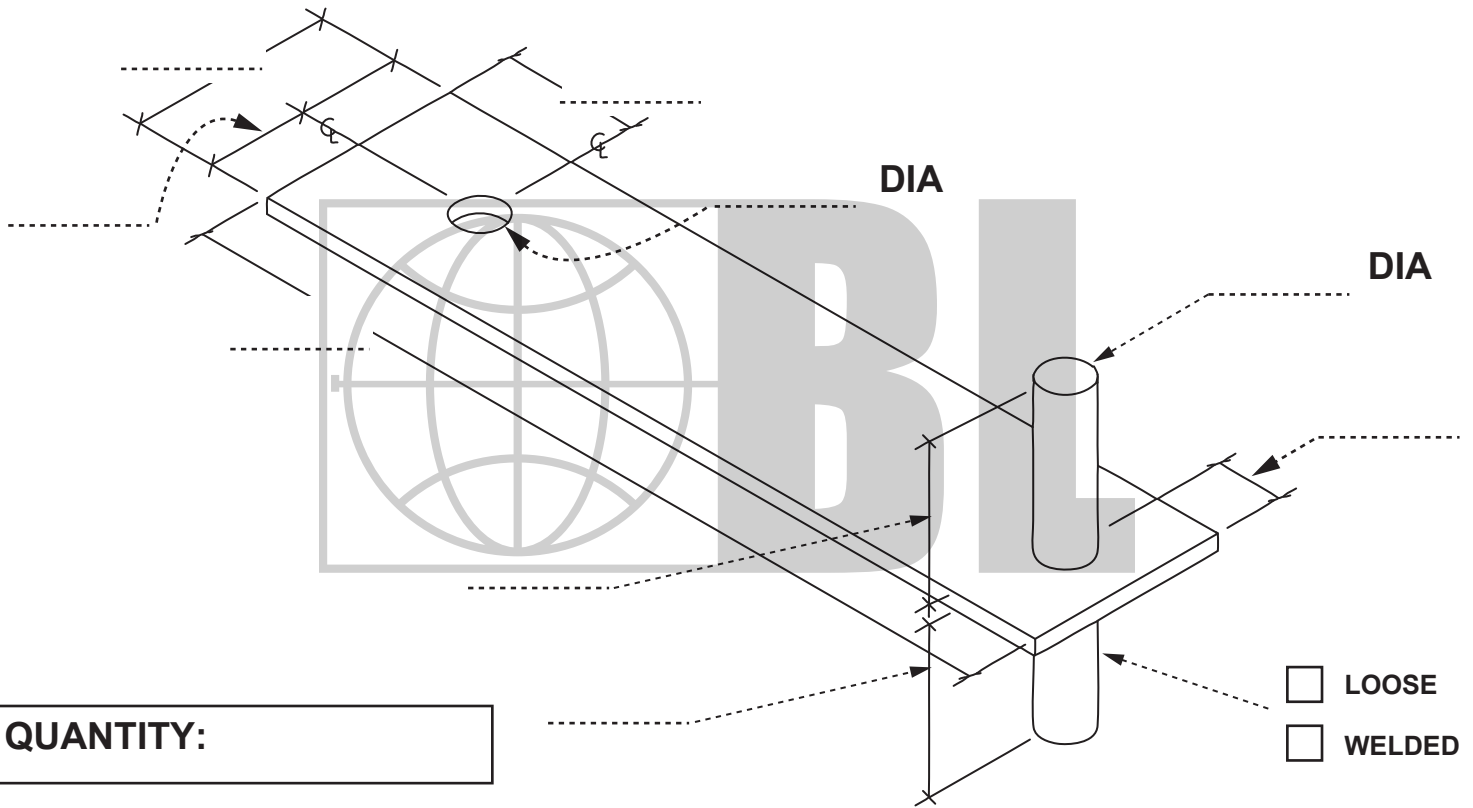

QUANTITY:

ST/ST Plate Min. Fy. = 45,000 p.s.i. (ASTM A666)
ST/ST Rounds Min. Fy. = 75,000 p.s.i. (ASTM A580)

DRAWINGS FOR ILLUSTRATIVE PURPOSES ONLY

FINISH:		THICKNESS:		
<input type="checkbox"/> TYPE 304 Stainless Steel	<input type="checkbox"/> TYPE 316 Stainless Steel	<input type="checkbox"/> 12 ga./2.78 mm	<input type="checkbox"/> 3/16"/4.7 mm	<input type="checkbox"/> 3/8"/9.5 mm
		<input type="checkbox"/> 1/8"/3.2 mm	<input type="checkbox"/> 1/4"/6.3 mm	<input type="checkbox"/> OTHER _____

Blok-Lok recommends the exclusive use of 304 or 316 ST/ST for stone anchorage.

PROJECT NAME:	CONTACT INFO
LOCATION:	Name :
NOTES:	Company:
	Phone: FAX:
	Email:

The appropriate selection and use of any product contained herein must be determined by competent architects, engineers and other professionals who are familiar with the specific requirements of the project.